

Product name: PK cable lug 25-16

STK code: 5201139

Weight (g): 16,5

 Wire size (mm²): 25

Nominal current (A): -

Nominal voltage (V): -

Installation: Crimping type tube connector

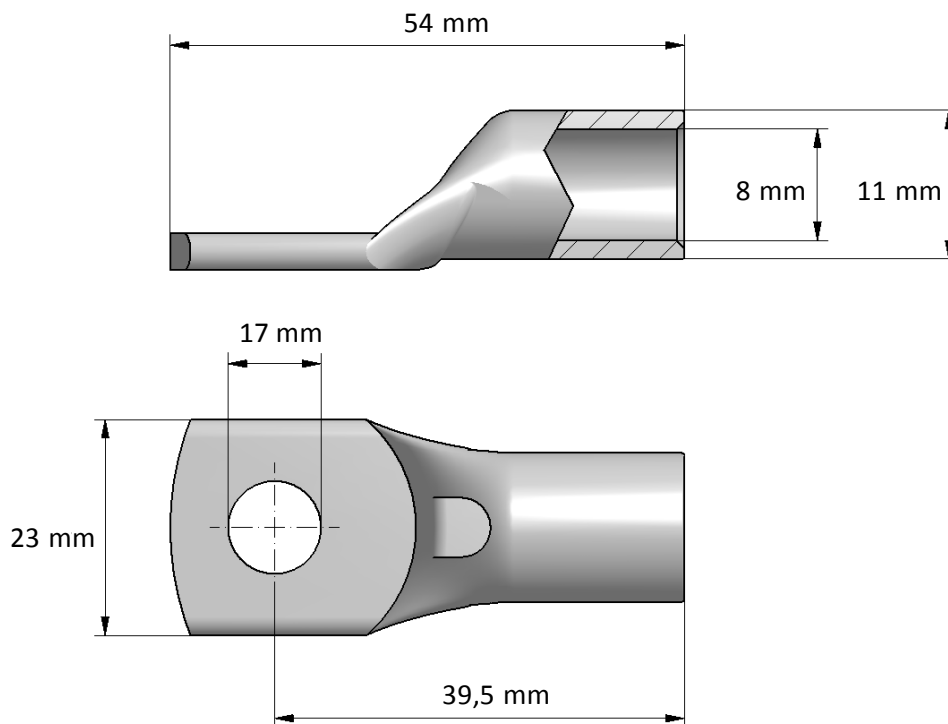

Product description

Ouneva copper cable lugs are designed for connecting copper cables, coils and busbars. The lugs are manufactured of 99,9% pure copper and electrolytically coated by tin. Cable lugs are also compatible with PEX cables. Installation of the cable lugs can be performed by the most basic crimping tools.

Package (pce): 100

Packing type: Box

Length (mm): 85

Height (mm): 85

Width (mm): 144

Volume (l): 1,040

Weight (kg): 1,701