

Product data

Product code	VC05-0013	STK-code	1914103	EAN-code	6410019141030
Product name	OTL-connector 1xAl/Cu 1,5-50mm² (Grey)				
Wires	1xAl/Cu 1,5-50mm²				

Technical data

Nominal current	Cu	160	A
	Al	145	A
Nominal voltage		1000	V
Max. Current (US)	Cu	150	A
	Al	120	A
Max. Voltage (US)		600	V
Number of pole		1	pcs
Max. Cross section		50	mm ²
Tightening torque	1,5-2,5 mm ²	1,5	Nm
	4-10 mm ²	5	Nm
	16-50 mm ²	12	Nm
	-	-	Nm
Max. Operating temperature		80	°C
Weight		30	g
IP-protection		IP20	
Standards	EN 61238-1; EN60947-7-1; UL1059		
Color/ Material	Grey RAL 7035/ PA66		
Mounting/ Connection	DIN-rail mounting		

Description

OTL-connectors are designed to be used connecting and branching aluminium and copper conductors. Bodies are made of tin-plated aluminium.

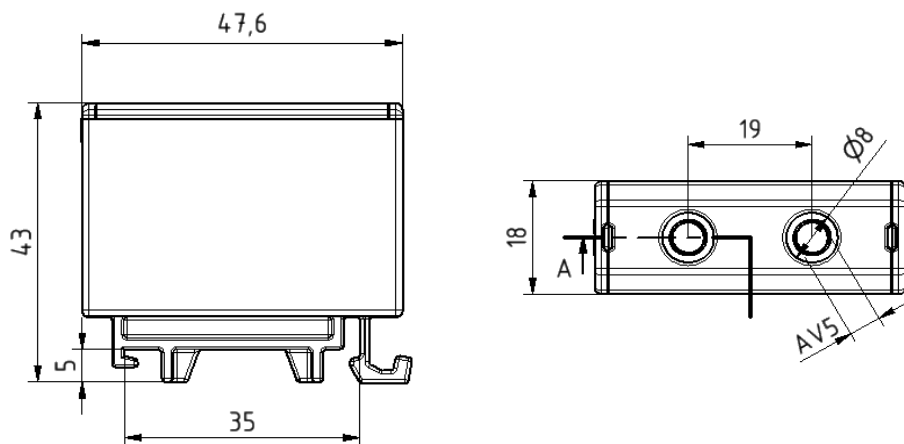
Drawing

Package

Package	Box	pcs/ package	50	Weight [Kg]	1,60
Length [mm]	210	Width [mm]	155	Height [mm]	105